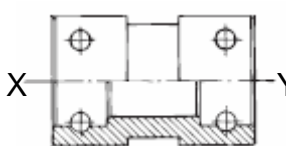
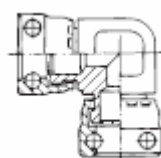
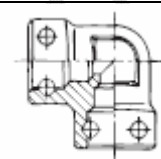
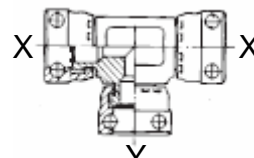
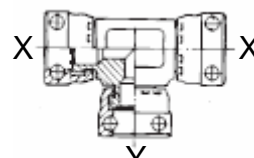

Super SteckO®

The Super SteckO Staple Concept is a high performance long life staple adaptor based on the System SteckO concept. Enhancements provide:

- Larger bore, high pressure capability
- Increased durability and impulse life
- Compatibility with multi-spiral hose applications

Following extensive testing and usage within mining, Super SteckO Staple provides the basis for high dynamic performance. Extensive research and development shows that the laminated staple design provides energy absorption that significantly increases the dynamic capabilities of the assembly. Adaptors are available with both male and female Super SteckO end terminations allowing conversion to NPTF, BSP threads.

STRAIGHT FIXED SUPER FEMALE		PORT SIZE					
		X			Y		
		INCH	DASH	DIN	INCH	DASH	DIN
		1/2"	8	12	1/2"	8	12
		3/4"	12	20	3/4"	12	20
		1"	16	25	1"	16	25
		1.1/4"	20	32	1.1/4"	20	32
		1.1/2"	24	40	3/4"	12	20
		1.1/2"	24	40	1.1/2"	24	40
		2"	32	50	1.1/2"	24	40
2"	32	50	2"	32	50		
3"	48	75	2"	32	50		
3"	48	75	3"	48	75		
90° SWIVEL SUPER FEMALE		PORT SIZE					
		INCH	DASH	DIN			
		1/2"	8	12			
		3/4"	12	20			
1"	16	25					
90° FIXED SUPER FEMALE		PORT SIZE					
		INCH	DASH	DIN			
		1.1/4"	20	32			
		1.1/2"	24	40			
2"	32	50					
SWIVEL SUPER FEMALE TEE		PORT SIZE					
		X			Y		
		INCH	DASH	DIN	INCH	DASH	DIN
		1/2"	8	12	1/2"	8	12
		1/2"	8	12	3/4"	12	20
		3/4"	12	20	3/4"	12	20
		3/4"	12	20	1/2"	8	12
1"	16	25	1"	16	25		
SWIVEL SUPER - SUPER - STANDARD FEMALE TEE		PORT SIZE					
		X			Y		
		INCH	DASH	DIN	INCH	DASH	DIN
		1/2"	8	12	3/8"	6	10
		3/4"	12	20	3/8"	6	10
3/4"	12	20	1/2"	8	12		

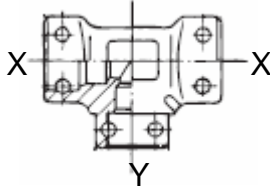
FIXED SUPER FEMALE TEE		PORT SIZE					
		X			Y		
		INCH	DASH	DIN	INCH	DASH	DIN
		3/4"	12	20	1/2"	8	12
		1"	16	25	1"	16	25
		1.1/4"	20	32	3/4"	12	20
		1.1/4"	20	32	1.1/4"	20	32
		1.1/2"	24	40	1/2"	8	12
		1.1/2"	24	40	1.1/4"	20	32
		1.1/2"	24	40	1.1/2"	24	40
		2"	32	50	1.1/4"	20	32
2"	32	50	2"	32	50		

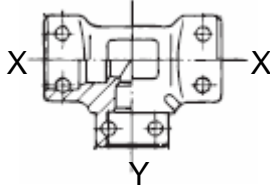
FIXED SUPER - SUPER - STANDARD FEMALE TEE		PORT SIZE					
		X			Y		
		INCH	DASH	DIN	INCH	DASH	DIN
		1"	16	25	3/8"	6	10

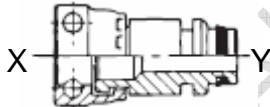
SUPER FEMALE - SUPER MALE		PORT SIZE					
		X			Y		
		INCH	DASH	DIN	INCH	DASH	DIN
		1/2"	8	12	1.1/4"	20	32
		3/4"	12	20	3/4"	12	20
		3/4"	12	20	1"	16	25
		3/4"	12	20	1.1/4"	20	32
		*1"	16	25	1"	16	25
		1"	16	25	1"	16	25
		1"	16	25	1.1/4"	20	32
		1"	16	25	2"	32	50
		*1.1/4"	20	32	1"	16	25
		*1.1/4"	20	32	1.1/4"	20	32
		*1.1/4"	20	32	1.1/2"	24	40
		*1.1/4"	20	32	2"	32	50
		1.1/4"	20	32	1.1/4"	20	32
		1.1/4"	20	32	1.1/2"	24	40
		1.1/4"	20	32	2"	32	50
		1.1/2"	24	40	1.1/4"	20	32
		*1.1/2"	24	40	1"	16	25
		*1.1/2"	24	40	1.1/4"	20	32
		*1.1/2"	24	40	1.1/2"	24	40
		*1.1/2"	24	40	2"	32	50
*2"	32	50	1.1/4"	20	32		
*2"	32	50	1.1/2"	24	40		
*2"	32	50	3"	48	75		

* FIXED FEMALE

CRESCO INDUSTRIAL

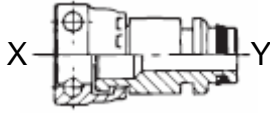
STANDARD FEMALE - SUPER MALE		PORT SIZE					
		X			Y		
		INCH	DASH	DIN	INCH	DASH	DIN
		1/4"	4	6	1/2"	8	12
		3/8"	6	10	3/4"	12	20
		3/8"	6	10	1"	16	25
		3/8"	6	10	1.1/4"	20	32
		*3/8"	6	10	1.1/4"	20	32
		1/2"	8	12	3/4"	12	20
		1/2"	8	12	1"	16	25
		1/2"	8	12	1.1/4"	20	32
		1/2"	8	12	1.1/2"	24	40
		1/2"	8	12	2"	32	50
		*1/2"	8	12	1"	16	25
		*1/2"	8	12	1.1/4"	20	32
		*1/2"	8	12	2"	32	50
		3/4"	12	20	3/4"	12	20
		3/4"	12	20	1"	16	25
		3/4"	12	20	1.1/4"	20	32
		3/4"	12	20	1.1/2"	24	40
		*3/4"	12	20	1.1/4"	20	32
		1"	16	25	1"	16	25
		1"	16	25	1.1/4"	20	32
		1"	16	25	1.1/2"	24	40
		1"	16	25	2"	32	50
		*1"	16	25	1"	16	25
		*1"	16	25	1.1/4"	20	32
		*1"	16	25	1.1/2"	24	40
1.1/4"	20	32	1.1/4"	20	32		
1.1/4"	20	32	1.1/2"	24	40		
1.1/4"	20	32	2"	32	50		
*1.1/4"	20	32	1.1/4"	20	32		
*1.1/4"	20	32	1.1/2"	24	40		
*1.1/4"	20	32	2"	32	50		
*1.1/2"	24	40	1.1/2"	24	40		
2"	32	50	1.1/4"	20	32		
*2"	32	50	2"	32	50		

* FIXED FEMALE

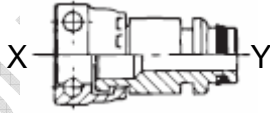
SUPER FEMALE - STANDARD MALE		PORT SIZE					
		X			Y		
		INCH	DASH	DIN	INCH	DASH	DIN
		*1/2"	8	12	3/8"	6	10
		*1/2"	8	12	1/2"	8	12
		3/4"	12	20	1/2"	8	12
		1.1/4"	20	32	1"	16	25
		1.1/4"	20	32	1.1/4"	20	32
		1.1/4"	20	32	1.1/2"	24	40
		*1.1/4"	20	32	1.1/4"	20	32
		*1.1/4"	20	32	1.1/2"	24	40
		*1.1/2"	24	40	1.1/4"	20	32

* FIXED FEMALE

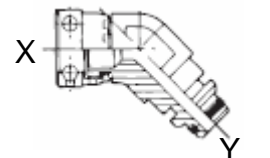
45° SUPER FEMALE - MALE		PORT SIZE					
		X			Y		
		INCH	DASH	DIN	INCH	DASH	DIN
		1/2"	8	12	1/2"	8	12
		3/4"	12	20	3/4"	12	20
		1"	16	25	1"	16	25
		1.1/4"	20	32	1.1/4"	20	32

* FIXED FEMALE

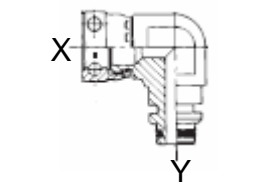
90° SUPER FEMALE - MALE		PORT SIZE					
		X			Y		
		INCH	DASH	DIN	INCH	DASH	DIN
		1/2"	8	12	1/2"	8	12
		3/4"	12	20	3/4"	12	20
		1"	16	25	1"	16	25
		*1"	16	25	1"	16	25
		*1.1/4"	20	32	1.1/4"	20	32

* FIXED FEMALE

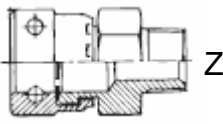
SUPER FEMALE - NPTF MALE		PORT SIZE			PORT THREAD (Z)
		INCH	DASH	DIN	
		1/2"	8	12	1/2" NPTF
		3/4"	12	20	3/4" NPTF
		1"	16	25	1" NPTF
		*1.1/4"	20	32	1.1/4" NPTF
		*1.1/2"	24	40	1.1/2" NPTF
*2"	32	50	2" NPTF		

* FIXED FEMALE

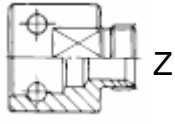
SUPER FEMALE - BSP MALE CONE 60°		PORT SIZE			PORT THREAD (Z)
		INCH	DASH	DIN	
		1"	16	25	1" BSP
		1"	16	25	2" BSP
		1.1/4"	20	32	1" BSP
		1.1/4"	20	32	1.1/4" BSP
		1.1/4"	20	32	1.1/2" BSP
		1.1/4"	20	32	2" BSP
		1.1/2"	24	40	1.1/4" BSP
		1.1/2"	24	40	1.1/2" BSP
		1.1/2"	24	40	2" BSP
		2"	32	50	1" BSP
		2"	32	50	1.1/4" BSP
2"	32	50	1.1/2" BSP		
2"	32	50	2" BSP		

SUPER FEMALE - BSP MALE		PORT SIZE			PORT THREAD (Z)
		INCH	DASH	DIN	
		3/4"	12	20	3/4" BSP
		*3/4"	12	20	1.1/4" BSP
		1"	16	25	1" BSP
		*1"	16	25	3/4" BSP
		*1"	16	25	1" BSP
		*1"	16	25	1.1/4" BSP
		1.1/4"	20	32	1.1/4" BSP
		*1.1/4"	20	32	3/4" BSP
		*1.1/4"	20	32	1" BSP
		*1.1/4"	20	32	1.1/4" BSP
		*1.1/4"	20	32	1.1/2" BSP
		*1.1/2"	24	40	1" BSP
		*1.1/2"	24	40	1.1/4" BSP
		*1.1/2"	24	40	1.1/2" BSP
		*1.1/2"	24	40	2" BSP
		*2"	32	50	1.1/4" BSP
		*2"	32	50	1.1/2" BSP
		*2"	32	50	2" BSP

* FIXED FEMALE

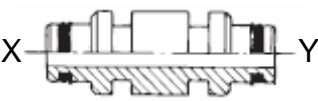
SUPER MALE - SUPER MALE		PORT SIZE					
		X			Y		
		INCH	DASH	DIN	INCH	DASH	DIN
		1/2"	8	12	1/2"	8	12
		1/2"	8	12	3/4"	12	20
		3/4"	12	20	3/4"	12	20
		3/4"	12	20	1"	16	25
		3/4"	12	20	1.1/4"	20	32
		3/4"	12	20	1.1/2"	24	40
		1"	16	25	1"	16	25
		1"	16	25	1.1/4"	20	32
		1"	16	25	2"	32	50
		1.1/4"	20	32	1.1/4"	20	32
		1.1/4"	20	32	1.1/2"	24	40
		1.1/4"	20	32	2"	32	50
		1.1/2"	24	40	1.1/2"	24	40
		1.1/2"	24	40	2"	32	50
		2"	32	50	2"	32	50
		3"	48	75	2"	32	50
		3"	48	75	3"	48	75

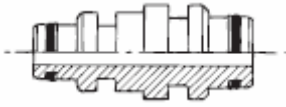
STANDARD MALE - SUPER MALE		PORT SIZE					
		X			Y		
		INCH	DASH	DIN	INCH	DASH	DIN
		3/8"	6	10	1/2"	8	12
		3/8"	6	10	3/4"	12	20
		3/8"	6	10	1"	16	25
		3/8"	6	10	1.1/4"	20	32
		3/8"	6	10	1.1/2"	24	40
		3/8"	6	10	2"	32	50
		1/2"	8	12	1/2"	8	12
		1/2"	8	12	3/4"	12	20
		1/2"	8	12	1"	16	25
		1/2"	8	12	1.1/4"	20	32
		1/2"	8	12	1.1/2"	24	40
		3/4"	12	20	3/4"	12	20
		3/4"	12	20	1"	16	25
		3/4"	12	20	1.1/4"	20	32
		3/4"	12	20	1.1/2"	24	40
		1"	16	25	1"	16	25
		1"	16	25	1.1/4"	20	32
		1"	16	25	1.1/2"	24	40
		1"	16	25	2"	32	50
		1.1/4"	20	32	3/4"	12	20
		1.1/4"	20	32	1"	16	25
		1.1/4"	20	32	1.1/4"	20	32
		1.1/4"	20	32	1.1/2"	24	40
1.1/2"	24	40	3/4"	12	20		
1.1/2"	24	40	1"	16	25		
1.1/2"	24	40	1.1/4"	20	32		
1.1/2"	24	40	1.1/2"	24	40		

SUPER MALE - NPTF MALE		PORT SIZE			PORT THREAD (Z)
		INCH	DIN	DASH	
		1/2"	8	12	3/4" NPTF
		3/4"	12	20	3/4" NPTF
		1"	16	25	1" NPTF
		1.1/4"	20	32	1.1/4" NPTF
		1.1/2"	24	40	1.1/2" NPTF
2"	32	50	2" NPTF		

SUPER MALE - BSP MALE		PORT SIZE			PORT THREAD (Z)
		INCH	DIN	DASH	
		1/2"	8	12	1/2" BSP
		3/4"	12	20	3/4" BSP
		1"	16	25	1" BSP
		1.1/4"	20	32	1" BSP
		1.1/4"	20	32	1.1/4" BSP
		1.1/4"	20	32	1.1/2" BSP
		1.1/2"	24	40	1" BSP
		1.1/2"	24	40	1.1/4" BSP
1.1/2"	24	40	1.1/2" BSP		
2"	32	50	2" BSP		

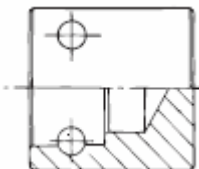
SUPER FEMALE END CAP		PORT SIZE		
		INCH	DASH	DIN
		1/2"	8	12
		3/4"	12	20
		1"	16	25
		1.1/4"	20	32
		1.1/2"	24	40
2"	32	50		

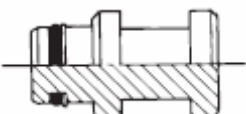
SUPER MALE PLUG		PORT SIZE		
		INCH	DASH	DIN
		1/2"	8	12
		3/4"	12	20
		1"	16	25
		1.1/4"	20	32
		1.1/2"	24	40
2"	32	50		

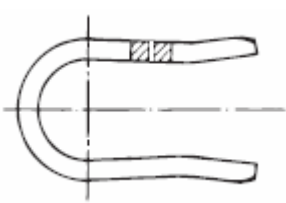
SUPER STAPLE (STAINLESS)		PORT SIZE		
		INCH	DASH	DIN
		1/2"	8	12
		3/4"	12	20
		1"	16	25
		1.1/4"	20	32
		1.1/2"	24	40
		2"	32	50
3"	48	75		

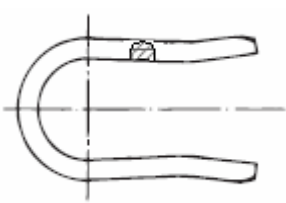
SUPER D-STAPLE (STAINLESS)		PORT SIZE		
		INCH	DASH	DIN
		1/2"	8	12
		3/4"	12	20
		1"	16	25
		1.1/4"	20	32
		1.1/2"	24	40
		2"	32	50
3"	48	75		

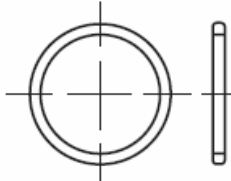
O-RING		PORT SIZE		
		INCH	DASH	DIN
		1/2"	8	12
		3/4"	12	20
		*1"	16	25
		*1.1/4"	20	32
		1.1/2"	24	40
		2"	32	50

* Interchangeable with Standard O-Ring

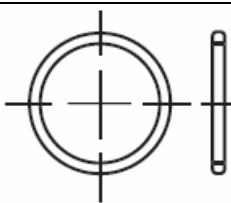
BACK UP RING		PORT SIZE		
		INCH	DASH	DIN
		1/2"	8	12
		3/4"	12	20
		*1"	16	25
		*1.1/4"	20	32
		1.1/2"	24	40
		2"	32	50

* Interchangeable with Standard Back Up Ring

CRESKO INDUSTRIAL SUPPLIES